

Data Sheet



Article number: 2307082791

Description: E+G Direct drive position indikator
DD52R-AR-0010.0-D-C3 (Grey)

Measures

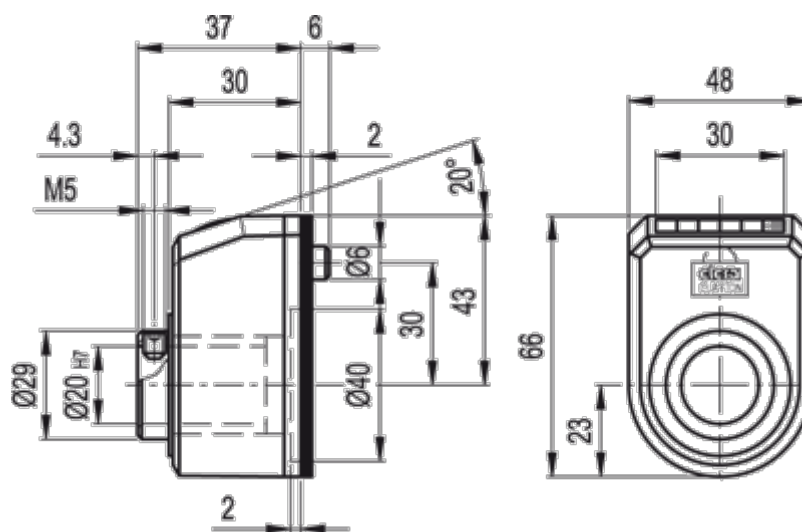

Max rpm = 250